

# BED-EDGER

CREATE A PERFECT LAWN EDGE

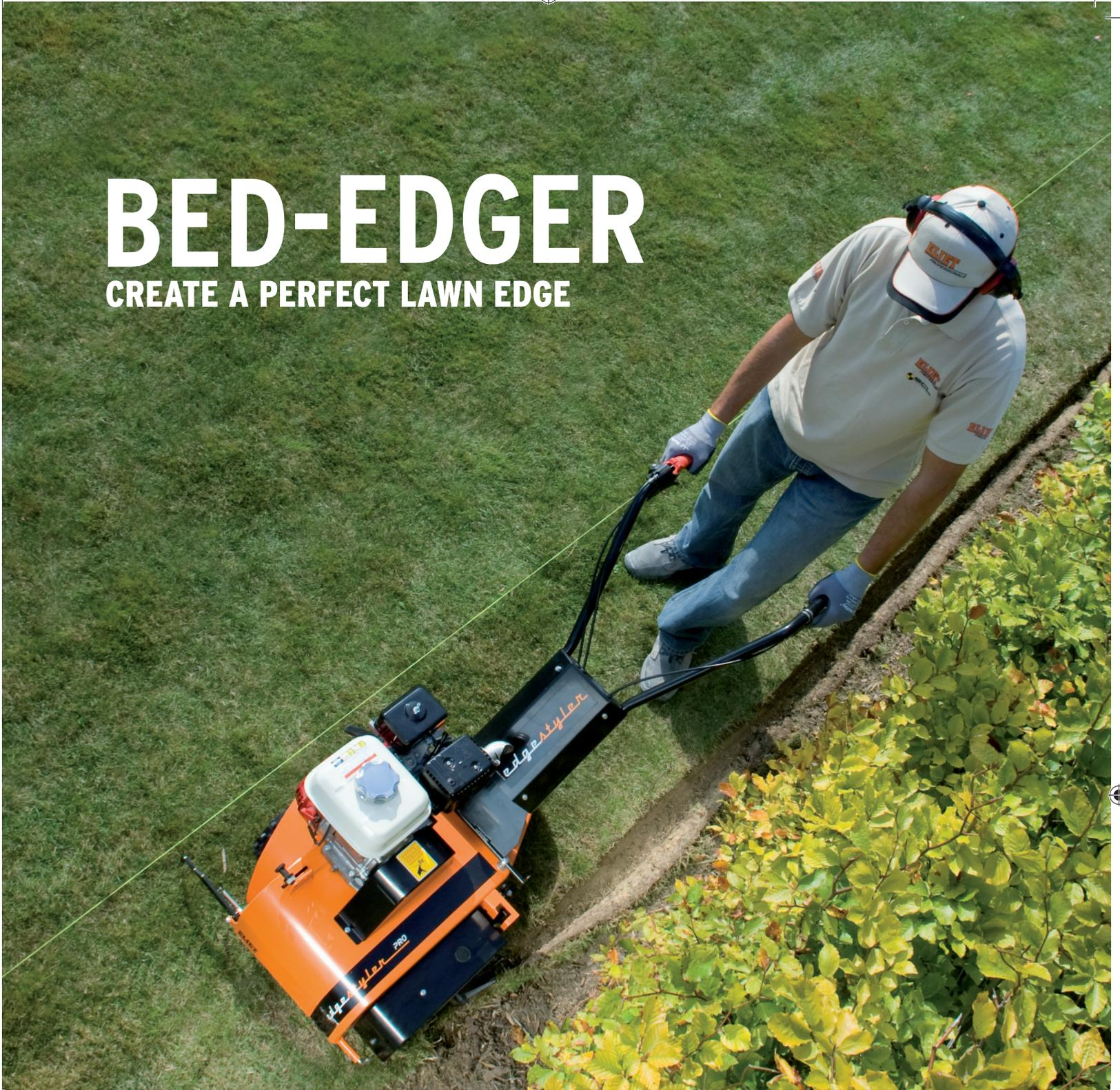

*edgestyler*

**ELIET**<sup>®</sup>

In harmony with nature



# edgestyler

## FOR PERFECT LAWN EDGING

Eliet, inventor of the Edge Styler and winner of the prestigious bronze prize at the 1996 Agribex international agricultural fair in Belgium, is proud to introduce its new Edge Styler for 2009. Our latest design is extremely maneuverable and user-friendly. Not only can you make perfectly straight edges but also nice winding beds, so that in landscape design nothing is impossible anymore. This new equipment will revolutionize the maintenance of golf bunkers.

## SAFETY FIRST

Safety is an integral part of Eliet's design concept. As with all Eliet equipment, the Edge Styler is extremely safe to operate. Our oscillating blade cuts soil as well or better than fast-spinning blades or rotating string machines, and without throwing dirt and stone projectiles. Once the blade comes out of the soil it doesn't move anymore. This safety feature, combined with the oscillating blade motion and the way the Edge Styler hugs the earth, makes operation safer for the operator and minimizes danger to bystanders.



ELIET Edgestyler PRO

ELIET Edgestyler STD

## RESPECT FOR THE ENVIRONMENT

With its efficient oscillating cutting motion, the Edge Styler doesn't need a lot of power to do the job, so the engine runs at a low 2800 rpm, still providing more than enough power for both propulsion and cutting. This saves on gas and reduces noise.



## VERSATILITY

Throughout the year, the Edge Styler can do many different jobs—major maintenance after the long winter period, and regular upkeep of your manicured lawn in spring and summer. Same for the end of the season when edges show signs of damage from weekly mowing. The Edge Styler is unparalleled at maintaining your lawn with safety and accuracy. During the mowing season, lawn mowers don't cut grass at the edge. For this job you can use a brush cutter or spinning wire trimmer, risking flying debris, or you can mount reciprocator blades on your Edge Styler. Instead of a wire trimmer or sidewalk edger, use your Edge Styler in safety anywhere, anytime, even in a crowded area. Last but not least, you can use the Edge Styler to make small trenches to put wires or hoses in the ground.



## CUTTER MECHANISM

Eliet does not use chains or other wear-sensitive or high maintenance parts. This increases durability and reliability of your equipment. In concrete terms, the hinge-point for the cutter head is lined up with the shaft that moves the cutter. The benefit is that the cutter movement places no stress or functional interference on the lift of the cutter head. This unique design brings maneuverability and balance to the edger, enhancing the user's ergonomic comfort.

# EDGE STYLER STD/PRO PROPERTIES



## STUDED WHEELS

A football player wears studded shoes in order to better grip the field of play. Eliet's Edge Styler features chunky studded wheels that provide a sure grip even when the turf is wet. Our wheels are made of rubber to prevent damage during repositioning, with cone-shaped studs to reduce rolling soil build-up.

## BLADE ENGAGEMENT PEDAL

To engage the blade into the soil, Eliet provides an easy-to-depress insert pedal, mounted on the right side of the edger. You simply step on the pedal with a gentle push of your foot, ratcheting the blade down to the desired cutting depth.



## FREE STYLE CURBING

Landscape architects are adding more and more curves in the design of lawns. The Edge Styler handles both straight-line and intricately curved edges with ease. Two features make this possible:

The edger is propelled by its two main wheels. Two wheels give better sideways stability, yet allows for extreme maneuverability. The third, rear wheel swivels so as not to negatively impact the maneuverability, yet provides increased comfort and ease of operation.

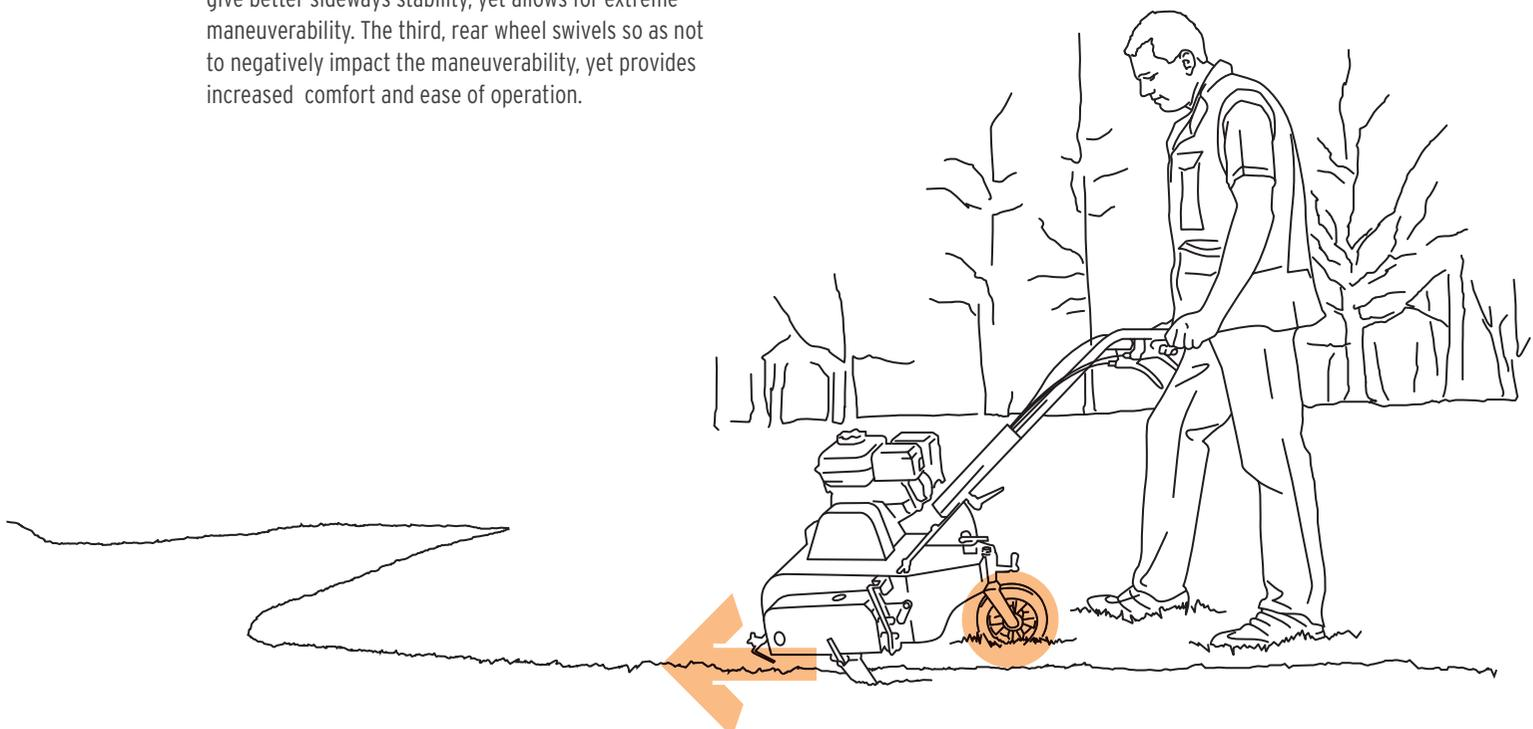

# EDGESTYLER STD/PRO PROPERTIES

## SWIVEL WHEEL

The third wheel is a swivel wheel and does not impact the maneuverability, but was added to increase the operator's comfort while in use. The oscillating cutting blade is aligned with the front wheel shaft, which enhances the precision of the work and makes it easy to follow curves.

The Pro model is equipped with rear wheel lock, making long, straight edges easier.



## PROPELLING

When the cutting blade goes forward, the propelling motion of the wheels helps the cutting. When the blade goes backwards the wheels keep going and absorb vibration. It is easy to engage the propelling action with the lever on the handle.

## LOW VIBRATION

Eliet's unique cutting action is derived from oscillating movement of the blade. In addition, we have achieved a perfect balance between weight allocation on the wheels and the inertia of the machine. The gravity center is very low, at the same level as the blade rod. By law of physics, the energy of the cutting pulse follows the easiest path—the blade imparts its energy into the soil, instead of shaking the machine.

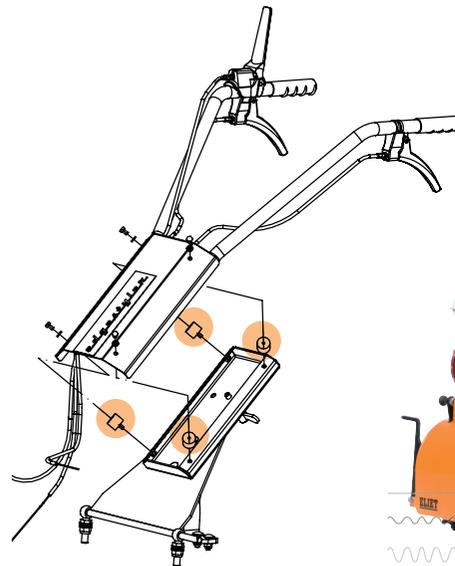

The pulse-cutting frequency is a low 15 Hz, fully absorbed by 210 pounds mass of the machine, which means vibration is reduced to a minimum.



On the Pro version, we added 4 shock absorbers on the handle to decrease high frequency vibrations.

# EDGESTYLER STD/PRO PROPERTIES



## GUIDE

When a lawn edge is damaged or eroded, you lack a reference to cut your new edge. In these situations it is appropriate to use a string or cord as a guide line. Our guide, mounted on the front of the edger, makes it easy to follow your guide line.

(The guide is standard on the Pro model and an option on the basic model)

## DOUBLE DRIVING SPEED

It is important to operate at the right speed, depending on the job and soil conditions. Eliet's design incorporates a two-stage reduction gearbox that reduces the incoming 2800 rpm by a ratio of 54:1! When you first engage the drive, the wheels turn slowly, avoiding spinning. The machine's speed then progressively increases to just under 1 mph (0.6 mph), the ideal speed to redefine a bed. The large cast-iron wheels are encased in studded rubber, with a footprint that mimics football shoes. Like a football player on turf, the Edge Styler maintains its grip on the soil so you can make sharp, precise cuts. The machine is sure-footed even at the beginning of the season and in the fall when the soil is wet, avoiding spinning and damage to the turf. The PRO version offers a choice of two driving speeds. A device on the steering bar allows for easy selection of the desired driving speed. A simple control on the steering bar allows you to double the driving speed.



## ADJUSTABLE HANDLE

The Eliet Edge Styler Pro adjustable, ergonomic handle provides operators with unparalleled comfort. We've already mentioned our efforts to reduce vibration to a minimum. Adjusting the handle to the ideal working position prevents physical strain your arms, back, and legs during lengthy jobs. And in some situations, you'll find the ability to offset the handle left or right is very convenient.

## ANTI-DEVIATION (TRACKING) DISC

During the redefining of an edge, the shape of the blade can sometimes tend to push the machine sideways. The Edge Styler Pro is equipped with a tracking (anti-deviation) disc to prevent this. This serrated disc can be dropped down into the soil and will keep your edger going straight. The disc is standard on the Pro model and is an option on the basic model.



# EDGESTYLER STD/PRO OPTIONS

## CHOICE OF BLADES

The Edge Styler was especially designed to mechanize the job of forming neat lawn edges. Our technique is to cut the soil in the manner of a spade. The blade actually makes a horizontal cutting movement that takes away a small piece of sod and leaves a polished edge face. The new design from our edger features a fast and easy way to change the blade without tools. Depending on the type of blade the machine can perform other tasks too:



**Standard blade** Normally, you will use a standard blade for free edges. The blade is available in different lengths. The blade has a "wing" (angled blade extension) that immediately pushes the sod to one side. You will notice that the blade has a horizontal blade surface. This ensures the edge is cut off horizontally as well as vertically.

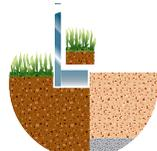

**Sidewalk blade** This is the ideal blade to cut adjacent to sidewalks or along a patio. The blade cuts a strip of sod and lifts it up, leaving a neat finish. The blade's cutting depth is only 20 mm, hence cannot be harmed by the underlying foundation.



**Golf bunker blade** This blade allows you to cut a high edge around sand traps or bunkers. For this application, you can also offset the handle, which eases the operator's task on sloping terrain.

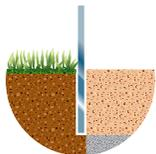

**Vertical blade** If your lawn is gradually starting to take over the terrace and you want to put some order back into your garden, the ELIET Edge Dresser provides you with the ultimate alternative. With this vertical blade, you can cut away the part of your lawn that is overgrowing. Afterwards, you can easily use a spade to lift away the loose sod from your terrace.



**Wire/cable trenching blade** For dog fencing and robot mowers, you will need to bury a cable to define the track limits. With this special blade and coil holder, you will be able to bury the cable approximately 2" inches deep without damaging the surface terrain. This feature is only available on the Pro model.



**U-shaped blade** If you wish to install an irrigation system or bury an electric cable under your lawn, ELIET offers a U-shape blade perfectly suited for making a temporary channel while causing minimum damage. When installation is complete, the trench can be filled in with the original sod plug.



**Edge cutting blade** The Edge Styler comes with an optional edge cutting kit. Thanks to an ingenious converter kit it takes only 5 minutes to transform the machine into a fully fledged edge cutter. In a scissor-like movement, two razor sharp blade disks cut the grass overgrowing lawn edges, terraces or walking paths to precision.



**Angular blade** If your lawn extends to your terrace or garden path, and you wish to create or remake the gap between these and your lawn, you need an angular blade. The ELIET Edge Dresser enables you to perform this work easily.



Standard blade		art. nr.
working depth	0,8 inch	BU 104 100 100
	1,6 inch	BU 104 100 200
	2,4 inch	BU 104 100 300
	3,2 inch	BU 104 100 400
4 inch	BU 104 100 500	

Vertical blade		art. nr.
length	1,6 inch	BU 104 101 100

U-shaped blade		art. nr.
width	1,4 inch	BU 104 102 100
	2 inch	BU 104 102 200
length	2 inch	

Angular blade		art. nr.
length	0,8 inch	BU 104 103 100
	1,6 inch	BU 104 103 200
	2,4 inch	BU 104 103 300

Sidewalk blade		art. nr.
working depth	1,8 inch	BU 104 104 100

Golf bunker blade		art. nr.
length	5,2 inch	BU 104 103 400
	7,2 inch	BU 104 103 500

Wire/cable trenching blade		art. nr.
working depth	2 inch	BU 104 104 202

Edgecutting kit		art. nr.
		MA 010 001 006

Custom made blades can be provided upon request.



----- soil

# EDGE TYLER STD/PRO OPTIONS



edge cutter blade on free lawn edge

## EDGE CUTTING KIT

In addition to dressing lawn edges, the Edge Styler can be converted into an edge cutter. Thus, after styling the lawn edge in spring, the machine can also be used to periodically cut the grass overgrowing the edge. The resulting quality of the edge reflects on your entire lawn and provides the finishing touch you were looking for.

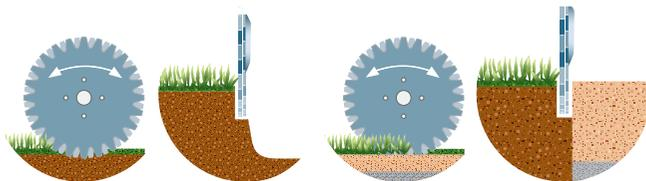

edge cutter blade on free lawn edge

edge cutter blade in between concrete border



## COMFORT AND SAFETY

The Edge Styler's cutting concept differs from the aggressive operation method of traditional edge cutters and allows the operator comfort and control while operating on winding lawn edges. Unlike any other edge cutter, all benefits of the Edge Styler apply to this application as well, i.e. wheel drive, low vibration handlebar, height adjustment, etc. On top, the Edge Styler is silent in use: the cutting mechanism requires very little power, allowing the engine to operate at lower RPM. And since the blade disk does not rotate, there is no risk of flying debris like turf, sand or stones. Additionally, cutting alongside pavements can be done without a risk of blade breakage. While offering nicely cut lawn edges, this Edge Styler kit also guarantees safe operation for both operator and any bystanders.

# EDGESTYLER STD/PRO OPTIONS



## MAINTENANCE FRIENDLY

The depth of the blade disk can be adjusted to a selection of fixed positions. Only a limited area on a blade disk is actively used. Worn blades don't require sharpening. Simply rotating the disk by one-eighth will produce a whole new set of razor sharp teeth. A blade disk only needs servicing or replacing after eight rotations.

## CONVERTER KIT EDGE CUTTING BLADE

Thanks to an ingenious converter kit it takes only 5 minutes to transform the Edge Styler into a fully fledged edge cutter. Contrary to traditional edge cutters that use a rotating blade to chop off the grass, the Edge Styler uses a scissor-like technique to cut the overgrown grass stalks.

The teeth of two blade disks, one moving, the other static, produce a scissor-like movement. Multiple pairs of "scissors" on the machine catch the grass and cut it to precision, without damaging the structure of the lawn edge.

## WEIGHTS

The Edge Styler PRO can optionally be equipped with a weight carrier, increasing the machine's weight with two 44 pounds disks at the rear. Adding the weight provides better wheel traction and diminishes vibration levels considerably, thus increasing user comfort. No tools are required for mounting the weights.

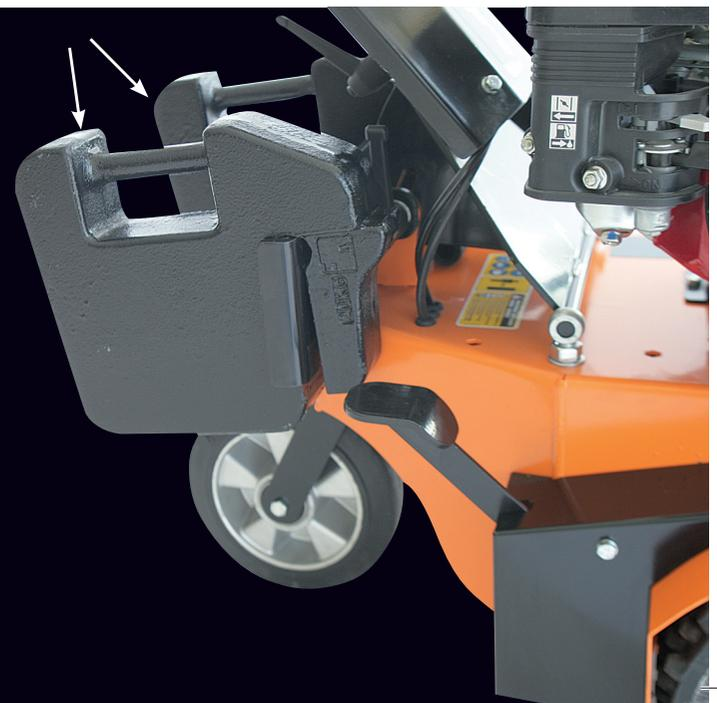

# EDGESTYLER PRO OPTIONS

## WIRE TRENCHING KIT

### 1/FOR ROBOTIC MOWERS

Because there's more to life than mowing the lawn, robotic mowers are increasingly taking over that task from humans, silently cutting the grass into a nice, even lawn. For you, it means more time to enjoy your garden and for the neighbours the absence of the typical noise of a traditional lawn mowing machine.

One reason why many people have not switched to a robotic lawn mower yet is the preparation required to lay the border wires around the mowable area. The ELIET Edge Styler PRO lightens that burden as well.

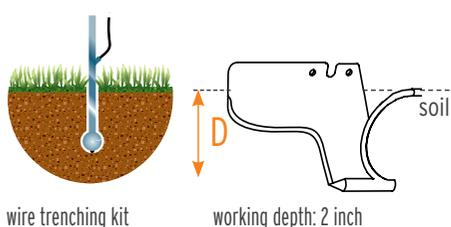

With a specially designed wire trenching blade and unwind system, the Edge Styler can work a DC voltage cable shallowly into the lawn. In less than two minutes and without the need for other tools, the wire trenching kit can be installed on the Edge Styler PRO. The unwind system is equipped to accommodate a variety of wires and reels.

The wire trenching kit has been adapted for use on robotic mowers of Ambrogio (Zucchetti), Robomow, Wiper (Zucchetti), Husqvarna Automower, Belrobotics, Lizard (Zucchetti), iMow (Viking)...

# EDGESTYLER PRO OPTIONS

The specially designed blade meticulously cuts through the grass turf without causing any visible damage. The DC wire is fed through the blade via a tube and dug into the lawn at a depth of approximately 2,4 inch. At this safe depth, the wire doesn't risk being damaged during later lawn treatment such as dethatching or overseeding.

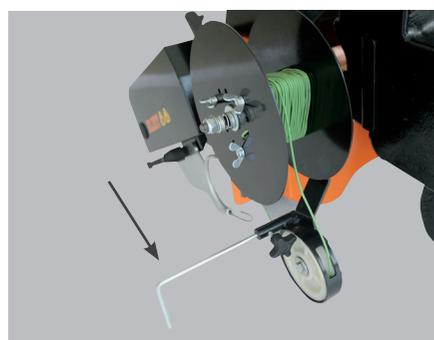

Another handy and time-saving tool is the adjustable distance guide. It allows burying the wire at exactly the right distance from the edge of the lawn without the need of marking the route with a rope in advance. The Edge Styler's well thought-out design, built up around the two centrally placed traction wheels, makes the machine extremely manoeuvrable and allows for easy wire trenching along curved lawns.

For a demonstration of how it works watch the video at [www.eliet.eu](http://www.eliet.eu).

## 2/ DOG FENCING

As a dog lover you feel responsible for your pet's safety. Whilst you and your family are enjoying your garden, you don't want to worry about your dog or cat. To ensure that your favourite pet doesn't cross the borders of the lawn, you can embed an invisible fence in the grass.

The system works by means of a transmitter collar which reacts to an underground DC wire, installed as a zone border. If the dog gets too close to the border of the marked area he receives a warning signal through the collar. Your perfect ally for the installation of this effective and aesthetic fence is the ELIET Edge Styler PRO; it will entrench the required wires in no time.

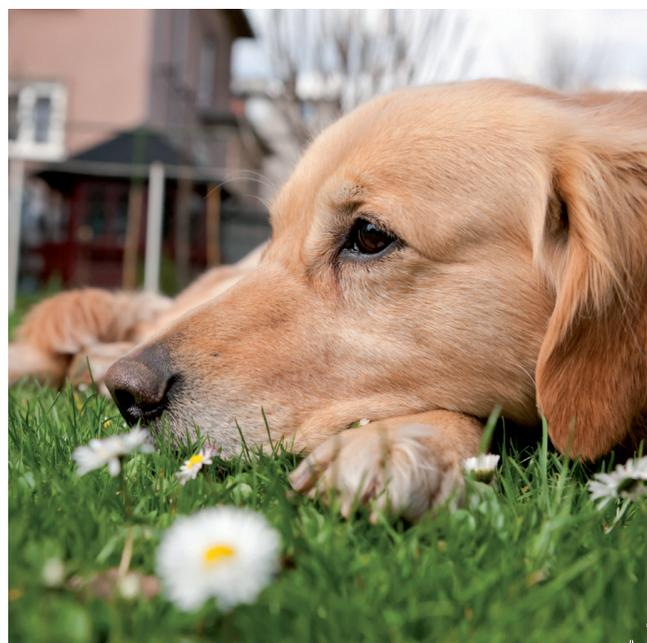

# TECHNICAL DATA



## PERFORMANCE

### STD PRO

Engine selection	4,0 HP Honda GC135	4,0 HP Honda GX120
Blade thickness	steel 0,12 inch	steel 0,12 inch
Blade speed	1000 cycl./min	1000 cycl./min
Driving speed (km/h)	0,55 miles/h.	adjustable between 0,55 or 1,24 miles/h.
Dept adjuster	depending on blade type	depending on blade type
Wheels (ØxW/material)	traction wheels 10x4 inch swivel wheel 8x2 inch	traction wheels 10x4 inch swivel wheel 8x2 inch
Transmission	rod with bearing belt transmission for knife belt transmission for wheeldrive	rod with bearing belt transmission for knife belt transmission for wheeldrive
Height adjustable handle	-	✓
Offset adjustable handle	-	✓
Anti-vibration handle	-	✓
Tracking Disc	option	✓
Guide	option	✓

## DESIGN

Dimensions (LxWxH in mm/inch)	50x22x37 inch	50x22x32/41 inch
Weight	181 pounds	208 pounds

## OPTIONS

U-form blade	✓	✓
Angular blade	✓	✓
Blade Golf Bunker	✓	✓
Sidewalk blade	✓	✓
Vertical blade	✓	✓
Edge cutting kit	✓	✓
Wire trenching blade	-	✓
Weight (max.88 lbs.)	-	✓
Bracket for weight	-	✓

The Edge Styler is a design of the Eliet Creative Lab™



Eliet Edge Styler is powered by:

**HONDA**



The unique concept of the Eliet Edge Styler was rewarded with the Bronze Spike innovation award at the international agricultural and horticultural show Agribex (Belgium) in 1996.

Visit us on the web at [www.elieta.eu](http://www.elieta.eu) to see our complete line of products.



Seeders



Overseeder



Side walk edgers



Power rakes



Chipper shredders



Blowers vacuum

# ELIET®

**ELIET Europe nv**  
Diesveldstraat 2  
B-8553 Otegem, België  
Phone +32 (0)56 77 70 88  
Fax +32 (0)56 77 52 13  
info@elieta.eu  
[www.elieta.eu](http://www.elieta.eu)

**ELIET USA INC.**  
3361 Stafford Street  
Pittsburgh, PA 15204, USA  
Phone +1 (0)412 367 5185  
Fax +1 (0)412 774 1970  
info@elietausa.com  
[www.elietausa.com](http://www.elietausa.com)

Dealer (Distributor):